

Clearing a Staple Jam

Clearing a staple jam of the 1,000-Sheet Finisher

- 1 Open the front cover.**

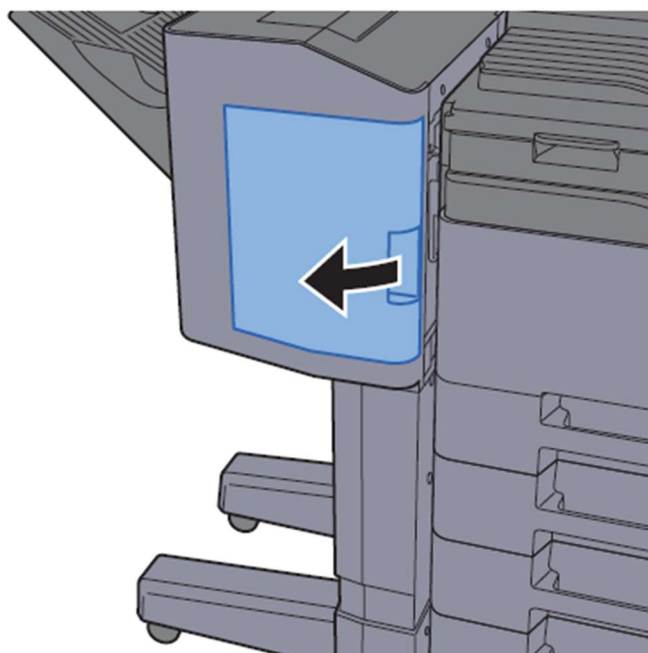

- 2 Remove the Staple Cartridge Holder.**

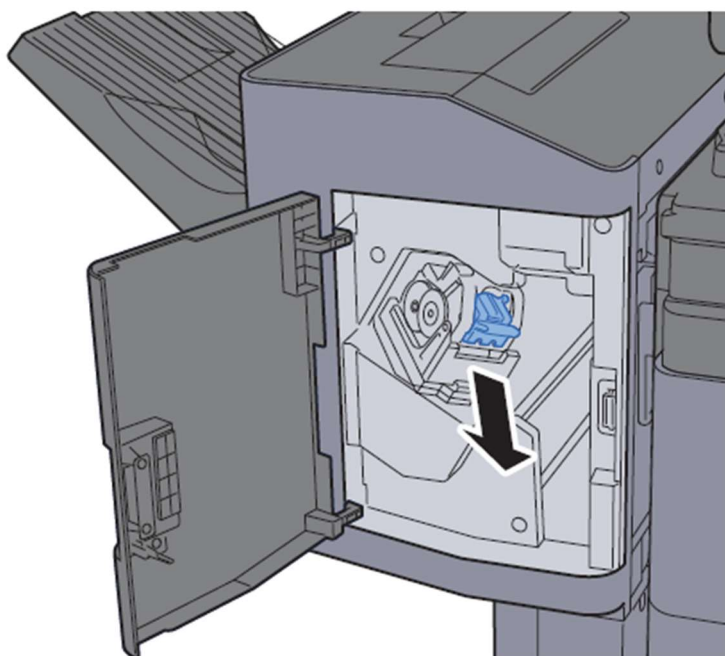

3 Remove the jammed staple.

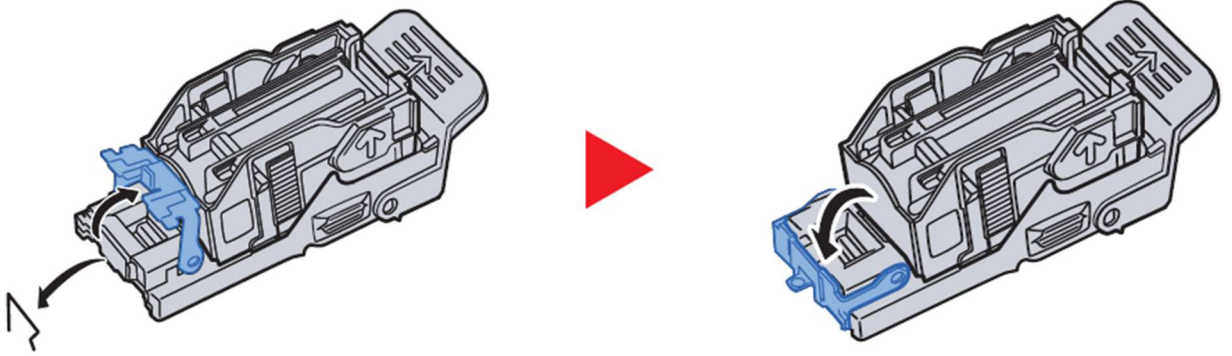

4 Install the Staple Cartridge Holder.

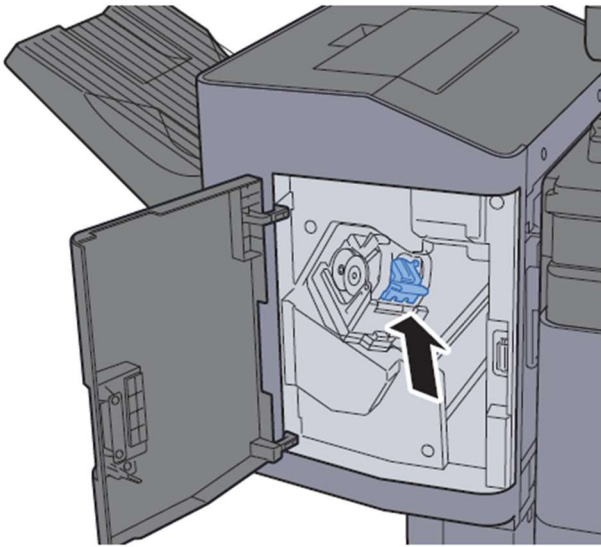

5 Close the front cover.

